

VELVET Mini Power 2 IP54

Ref.: VMP2IP54

Datasheet: June 2021 / Page 1



Bicolor weatherproof compact panoramic concentrated light LED panels

[Click here for more product information](#)

VMP2IP54 includes: DC in XLR-3, DMX in XLR-5,
1x yoke with 28mm junior pin - 16mm baby receiver

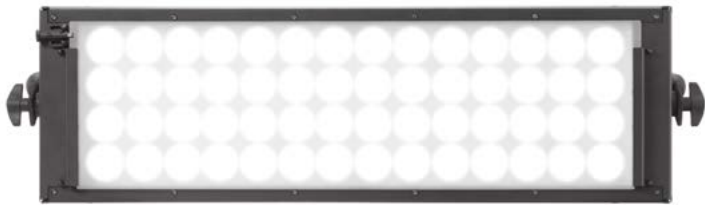

1. Power switch
2. XLR-3 DC In Connector
3. Docking plate
4. +/- Adjustment buttons
5. 3200K / 5600K Quick access button
6. Mode selection button (Dimmer / Colour Temperature)
7. Digital display
8. XLR-5 DMX RDM In & Out connector



VELVET Mini Power 2 IP54

Ref.: VMP2IP54

Datasheet: June 2021 / Page 2



COLOUR TEMPERATURE	adjustable from 2700K to 6500K in 100K steps
LIGHT INTENSITY	dimnable 0 to 100, smooth and flicker-free
TLCI INDEX	93 at 3200K and 96 at 5600K
DIMENSIONS	607 x 190 x 90 mm (panel) 24" x 7.5" x 2.5" 680 x 275 x 90 mm (panel + yoke)
WEIGHT	3 kgs / 6.5 lbs (panel) 3.4 kgs / 7.5 lbs(panel + yoke)
POWER DRAW	120 W
POWER SUPPLY	12 – 35 VDC through Vock or Gold battery mount plate 90-264 VAC 50/60Hz through Smart Vlock or Gold AC adapter
BEAM ANGLE	35°
PHOTOMETRICS	9000 lux / 833 fc at 1m / 3 feet 1200 lux /110 fc at 3m / 10 feet
LED RATED LIFE	more than 50.000 hours L70
POWER CONNECTION	Vock or Gold removable battery mount plate
DMX	DMX-RDM with XLR-5 in connector
OUTPUT FREQUENCY	16KHz flicker-free up to 2000fps
OPERATION TEMPERATURE	from -20°C to +40°C
COOLING	no-noise, fan-free passive cooling
PROTECTION	IP54 weatherproof, indoor or outdoor use
VELVET LED TECHNOLOGY	selected BIN high-power LED + custom optics + optic diffuser + CPU software control
RIGGING OPTIONS	aluminum yoke with 16 baby receiver combined with 28 junior pin, multiple ¼-20" rigging points, multipanels yokes, pole-operated studio yoke
QUICK MOUNTING ACCESSORIES	Smart Vlock AC power supply, quarter, half and full hard diffusion, foldable Snapgrid, removable barn doors, remote control, cordura case, hard case
CONSTRUCTION & FINISH	Made of black powdercoated extruded and sheet aluminum

WIRE VIEW

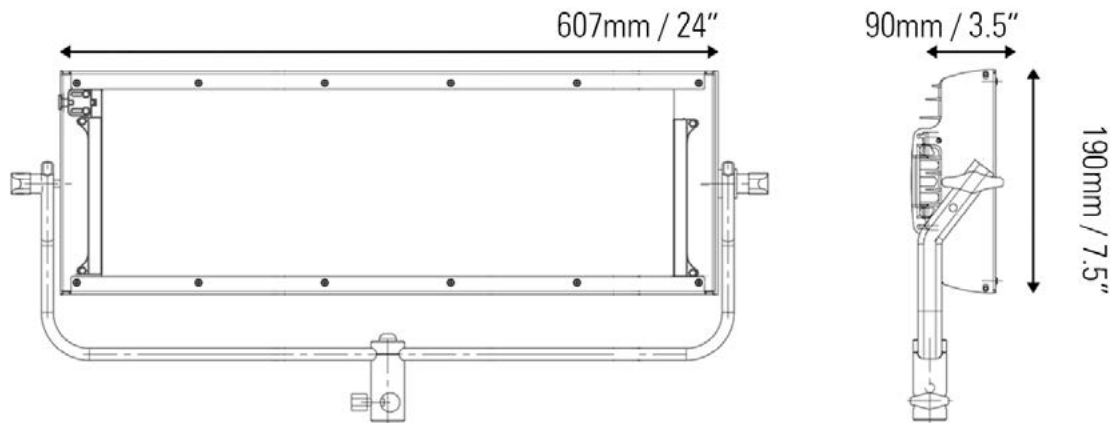

VELVET Mini Power 2 IP54

Ref.: VMP2IP54

Datasheet: June 2021 / Page 3



PHOTOMETRICS

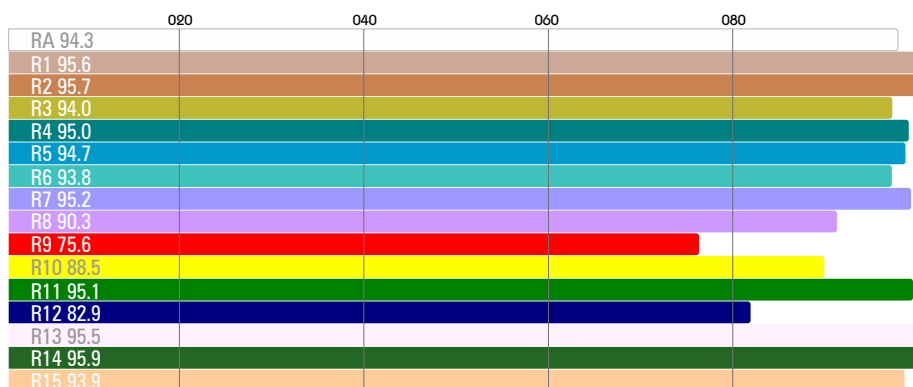
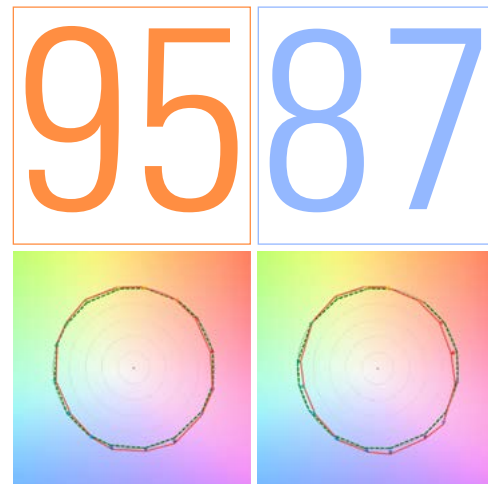
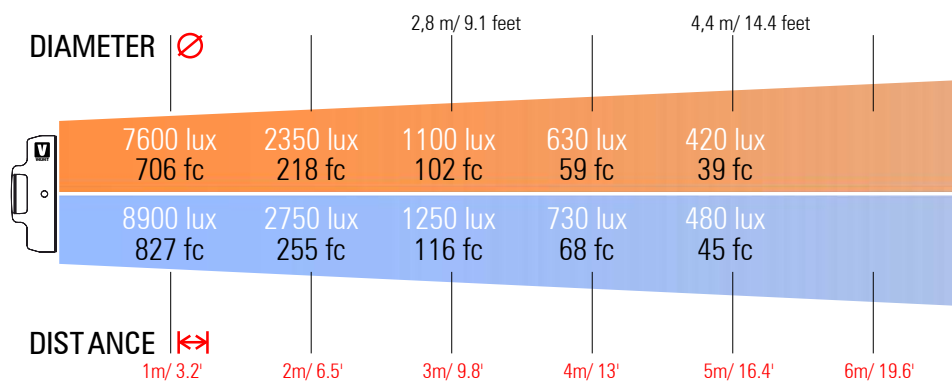

CCT 3294K

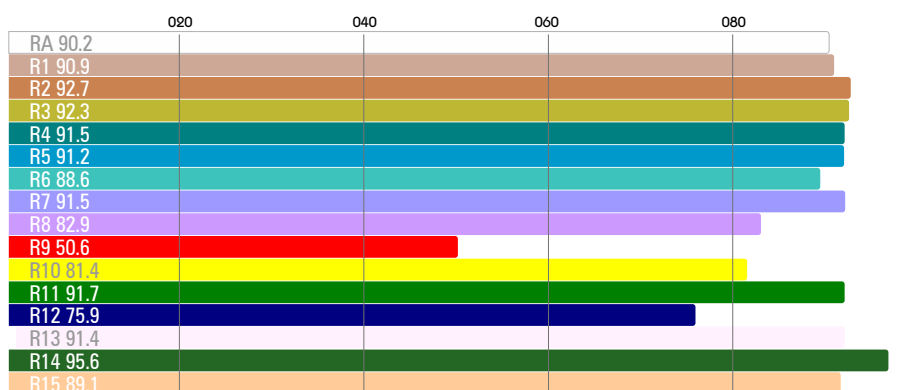

CCT 5644K















VELVET Mini Power 2 IP54

Ref.: VMP2IP54

Datasheet: June 2021 / Page 4



ACCESSORIES

POWER SUPPLY		TRANSPORT	RIGGING
			
VM-PSU200WVL	VM-PSU200WGL	VM2-BAG	VM-QLS
BEAM CONTROL			
			
VMP2-D25	VMP2-D50	VMP2-D100	VM2-RB
			
VM2-SG	VM2-SB	VM2-SGXSB	
BATTERY ADAPTERS		REMOTE CONTROL	
			
VM-VLOCKIP54	VM-VLOCKA	VM-GOLDA	VL-RC